





HAKKIMIZDA

Sektörde 17. Yılını tamamlayan Elegas Asansör yurt içi ve yurt dışında sayısız projelere imza atmıştır. Elegas; Her türlü projeler için yüksek deneyimli mühendis kadrosuyla asansör tasarım, üretim ve montajını yapmakta olup, servis imkânı da sağlamaktadır. 2 duraklı, yüksek hızlı grup sistemleri, yürüyen merdiven ve yürüyen yollar 'a kadar çok geniş çözümlere sahiptir. Müşterilerimizin üretim, montaj ve bakım sırasında oluşan talepleri Avrupa Standartlarına (CE, ISO 9001-2015, EN 81-1, EN 81-20), Rusya Standartlarına (EAC) sahip ürünler ile cevap vermektedir.

Ülkemizdeki ve Dünyadaki gelişmeleri yakından takip eden genç ve dinamik kadromuz ile teknolojik gelişimi ve yeniliği hedefleyen firmamız, müşteri odaklı hizmet anlayışı ile sektörde bir dünya markası olma vizyonu ile yoluna devam edecektir.

ABOUT US

17 In the industry. Having completed its year, Elegas Elevator has signed numerous projects at home and abroad. Elegas; Performs elevator design, production and installation with its highly experienced engineer staff for all kinds of projects and also provides service opportunities. it has a wide range of solutions, including 2-stop, high-speed group systems, escalators and walking paths. We respond to the demands of our customers during production, installation and maintenance with products that meet European Standards (CE, ISO 9001-2015, EN 81-1, EN 81-20), Russian Standards (EAC).

Our company, which aims at technological development and innovation with our young and dynamic staff who closely follows the developments in our country and the world, will continue its way with the vision of becoming a world brand in the sector with its customer-oriented service approach



çözüm
alanlarımız

our
solution
areas

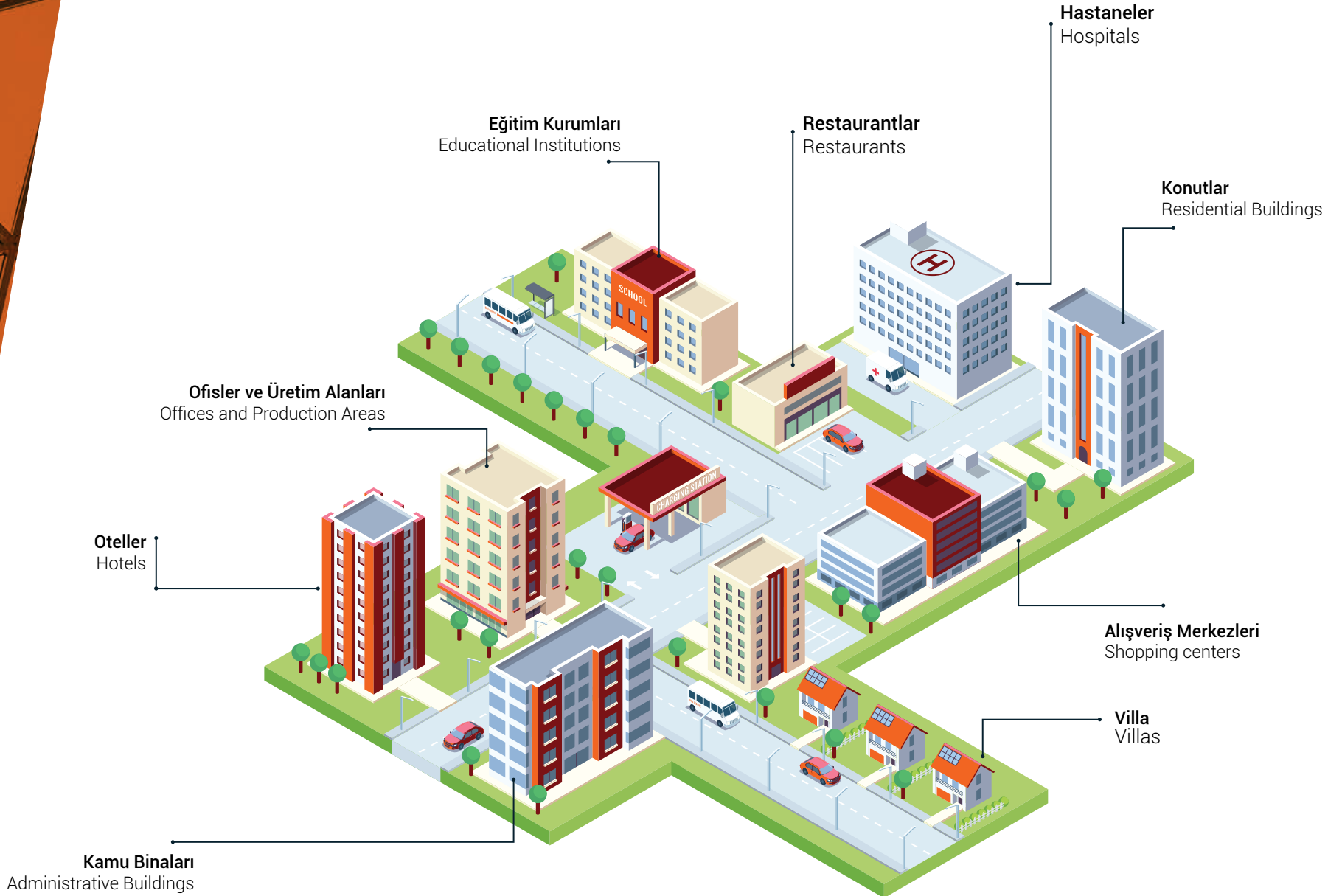



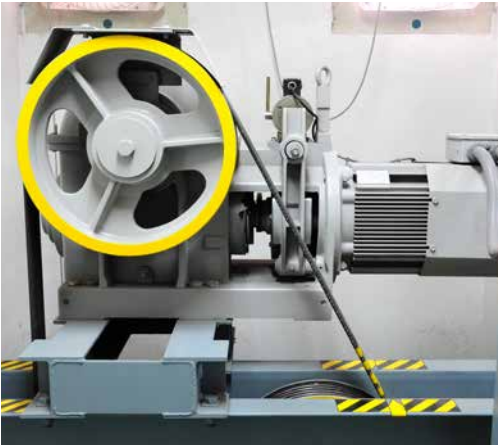

Makine daireli asansörler; Asansör tahrik makinasının asansör kuyusunun üzerinde teşkil edilmiş bir oda içerisinde bulundurulduğu asansör tipidir. Asansör makine dairesi, asansör kuyusunun bir parçası olarak genellikle kuyu üstünde bulunan, asansör makinesi ve asansör teçhizatının içinde bulunduğu makine dairesinin de incelenmesi gerekir. Bu alanın dış etkenlerden korunmuş rutubetsiz, yeterli aydınlıkta (en az 200 lüks ve stroboskopik yanılğıdan etkilenmeyecek şekilde aydınlatılmış), iyi havalandırılan, ortam sıcaklığı +5~+40 derece arasında korunabilen, ses ve titreşimleri önleyecek şekilde düzenlenmiş olması gerekir.



Machine room elevators; The lift shaft of the elevator drive machine It is a type of elevator in which a room is placed on it. The elevator engine room is usually used as part of the elevator shaft. in the elevator machine and elevator equipment the engine room in which it is located should also be examined. External factors of this area protected from moisture, sufficient brightness (at least 200 lux and stroboscopic well-ventilated, Ambient temperature can be maintained between + 5 ~ + 40 degrees, sound and vibrations must be arranged to prevent.



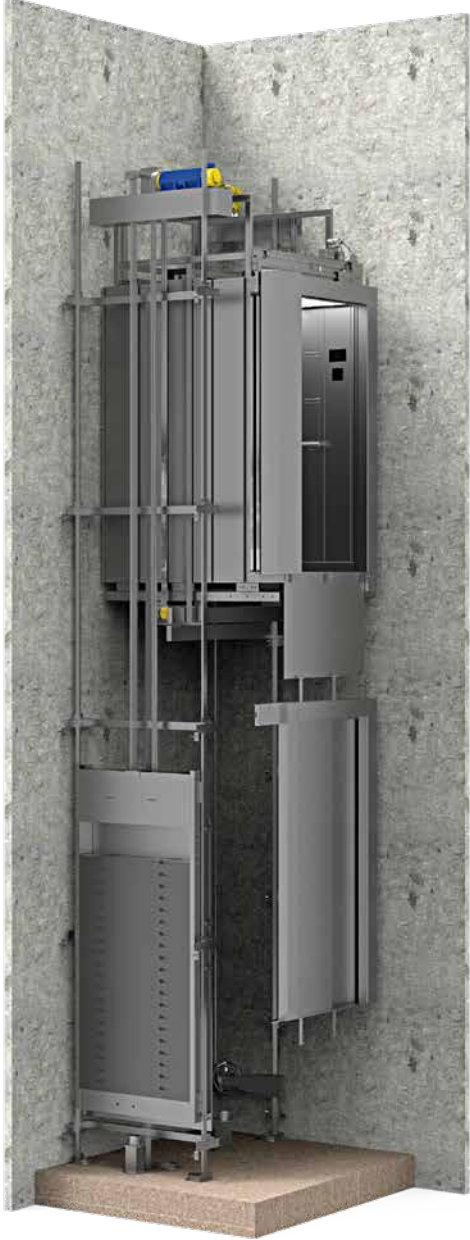

Makine daireleri binaların üzerinde belirgin bir yapıya sahiptir ve bina üzerinde belli bir yer kaplamaktadır. Makine dairesinin kapladığı alan çoğu zaman bina estetiğine uymaz. Bu yüzden dişlisiz makineler üretime girmiştir. Bu makine, frekans kontrollü çalışıp, asansörün duruş kalkış ve tek hareketli parçasıyla kabinin seyrine büyük bir konfor sağlar. Dişlisiz makine sayesinde, makine dairesi ortadan kalkmakta ve asansör kuyusu içerisinde, montajın gerçekleştirilmesi sağlanmaktadır. Montajı yapılan dişlisiz makine bir disk şeklinde olup, asansör makinesinin ağırlığının yarısı kadar ağırlıktadır. Kullanılan bu makine hassas kalkış ve duruşlarıyla, sessiz ve titreşimsiz çalışmasıyla büyük konfor sağlar. Dişlisiz makine diğer asansör makinelerine oranla çok daha verimlidir. Ayrıca enerji tüketiminde geleneksel asansör motorlarına göre %40 daha az enerji tüketmektedir.



Machine rooms have a distinctive structure on the buildings and covers a certain place. Space occupied by the engine room most of the time it does not fit the aesthetics of the building. That's why gearless machines entered into production. This machine operates in frequency controlled stance take off and a large comfort. Thanks to the gearless machine, the engine room is eliminated installation in the elevator shaft it is provided. The mounted gearless machine is in the form of a disc, it weighs half the weight of the elevator machine. This machine is used for precise starting and stopping, quiet and vibration free operation provides great comfort. Gearless machine other lift machines are much more efficient. Also in energy consumption consumes 40% less energy than conventional elevator motors.





Panoramik Asansörler şeffaf cam kabinli asansörlerdir. Bu asansör seyir sırasında etrafı gözlemlemeyi sağlamaktadır. Genellikle, bu tür bir asansör banka kurumlarına, otellere, alışveriş ve eğlence merkezlerine kurulur.



Panoramic elevator lifting mechanism with a transparent or translucent cabin. During the trip on this elevator you can see the surrounding space. As a rule, this type of lift is installed in banking institutions, hotels, and shopping and entertainment centers.





Hidrolik asansör, asansör makine dairesi bulunmayan, trafik yoğunluğunun düşük olduğu ve belli seyir mesafelerine sahip binalarda kullanılan bir asansör çözümdür. Makine dairesi yerine, hidrolik ünitesinin monte edileceği uygun bir zemin yeterlidir. İhtiyaca göre insan, yük, araç taşımak için kullanılabilir gibi; mağaza, depo, fabrika gibi alanlarda yük platformu olarak tasarlanan kaldırma araçlarında hidrolik hareket sistemi kullanılır. Adından da anlaşılacağı gibi hidrolik asansörler, hidrolik yağ basıncı kullanılarak piston vasıtası ile kabin hareketi sağlar. Asansör kabinin aşağı yönü hareketinde kabinin kendi ağırlığından faydalanılırken, kabin yukarı yönü hareketi için hidrolik yağ basıncı kullanılır.



Hydraulic lift, elevator without engine room, traffic low density and with certain cruising distances is an elevator solution used in buildings. Instead of the engine room, a suitable floor on which the hydraulic unit is to be installed is sufficient. According to the need to carry people, cargo, vehicles as can be used for; In areas such as store, warehouse, factory hydraulic lifting platform designed as a load platform motion system is used. Hydraulic as the name suggests lifts by means of a piston using hydraulic oil pressure provides cabin movement. In the downward movement of the elevator car while the car's own weight is utilized, the car's upward direction hydraulic oil pressure is used for movement.



4.OG Station B4
3.OG Station B3

2.OG Wohnbereich
1.OG Chefarzt
Anmeldung
Therapiebereich

EG Physiotherapie
Zugang Klinik
Ausgang (Haus A)
Patienten-Café
(Haus A)



Sedye asansörleri hastanelerde sedye üzerine yatırılan hastaların taşınması için tasarlanmıştır. Sedye asansörlerinden asıl amaç konfordur. Sedye asansörleri diğer asansörlerin sarsılması kadar bir sarsıntıya sahip olmamalıdır. En ufak bir sarsıntı bile sedye üstünde yatan bir hasta için bir tehdit unsuru olacaktır. Bunun yanında anti bakteriyel bir ortama ihtiyaç vardır. Sedye asansörleri paslanmaz çelik kaplamalarına sahiptir. Hastaların hiçbir şekilde rahatsız olmamaları için tasarlanmıştır. Asansör kabınınin içinde ki her ayrıntı çok önemli olmaktadır. Sedyede yatan herhangi bir hastanın rahat bir şekilde taşınması tutunma kolları, aydınlatma sistemleri ve diğer otomatik sistemlerle birlikte estetik bir yapıda olması çokönemlidir. Kabin içi boyutları opsiyonel olarak belirlenmiştir. Bunun yanında taşıma kapasitesi olarak da 1250, 1600, 2000 ve 2500 kg gibi taşıma kapasitelerine sahip olabilir.



Stretcher lifts of patients hospitalized on stretchers Designed for transporting. Stretcher elevators The main purpose is comfort. Stretcher elevators of other elevators should not have a concussion. The smallest a jolt is a threat to a patient even lying on a stretcher element. In addition, an antibacterial environment are needed. Stretcher Lifts Stainless Steel Finishes It has. Patients are not disturbed in any way Designed for. Every detail in the elevator car is important. The comfort of any patient lying on a stretcher way of transporting handles, lighting systems and other automatic systems. is very important. Interior dimensions are optional. that 1250, 1600, 2000 and 2500 as carrying capacity kg.





Günümüz şartlarında çoğalan araba sayısı otopark ihtiyacını ortaya çıkartmış ve bu ihtiyaç ciddi bir sorun haline almıştır. Yapılan binalarda otopark için yeterli alan ayrılmadığından binaların üstü ve bodrum katları otopark amaçlı kullanılmaya başlamıştır. Araç Asansörü, dikey taşımacılık ile maksimum sayıdaki aracın en kısa zamanda katlar arasında ulaşımının sağlanması amacıyla imal edilmektedir.

Araç Asansörü, otoparklarda, hastanelerde, iş merkezlerinde, avm gibi şehrin en kalabalık noktalarında araç ve yük taşımak amacıyla kullanılan, ortalama olarak 2000 kg ile 10.000 kg arasında değişen taşıma kapasitesi olan asansör tipidir.



In today's conditions, the number of cars that multiply has revealed the need for parking, and this need has become a serious problem. Since there is not enough space for parking in the built buildings, the top and basements of the buildings have started to be used for parking purposes. The vehicle lift is manufactured with the aim of ensuring vertical transportation and transportation of the maximum number of vehicles between the decks as soon as possible.

A vehicle elevator is a type of elevator that is used to carry vehicles and loads in the most crowded points of the city, such as parking decks, hospitals, business centers, shopping malls, with a carrying capacity ranging from 2000 kg to 10,000 kg on average.





Tubelift oval yapısı ile en küçük merdiven boşluklarına kolayca uygulanır. Şaft ihtiyacı olmayan Glass Home Elevator modellerinden TubeLift, 28 metre seyir ve 7 durağa kadar yüksekliklerde güvenle uygulanır. Oval cam kapıları ve yuvarlak cam kabini ile evlerinizde aydınlık ve ferah ortamlar yaratır. Panoramik görünümü şık ve modern çizgileri ile evlerinizde geleneksel asansör modelleri dışında kusursuz oval hatları ve yuvarlak yapısı ile küçük asansör arayanların gözdesidir.



Tubelift is easily applied to the smallest stairwells with its oval structure. TubeLift, one of the Glass Home Elevator models that does not need a shaft, is safely applied at heights up to 28 meters and 7 stops. It creates bright and spacious environments in your homes with its oval glass doors and round glass cabinet. With its panoramic view, stylish and modern lines, it is the favorite of those looking for a small elevator with its perfect oval lines and round structure, apart from the traditional elevator models in your homes.







Yemek (Monşarj) Asansörleri, restaurant,kafeterya, depo, ofis, otel, ev, sağlık kurumları ve laboratuvarlar, kuyumcular ve benzeri yerlerde, yemek taşınması, evrak taşınması, küçük ebatta eşya taşınması gibi işlerde kullanılmak üzere kullanılan küçük ebatta asansör sistemleridir. İhtiyaca ve kullanıma göre; hidrolik ve tamburlu tip olabilir. Yemek (Monşarj) Asansörleri, prensipte insan asansörünün küçültülmüş halidir. Kapılar giyotin tip veya klasik çarpma tip olarak kullanılabilir.



Dumbwaiters Elevator are mostly used at restaurants, cafes, warehouses, offices, hotels, houses, medical centers, laboratories and jewellery shops where we need vertical transportation for small size cargos, food stuff and documents. Purpose and usage bring us 2 models, hydraulic or drummed types. In basic principles, Dumbwaiters Elevators are minimized version of elevators..





Asansör Kabinleri | Elevator Cabins



ELG-001

Kaplama / Material

Ayna / Mirror

Küpeřteler / Handrails

Tavanlar / Ceilings

Zemin / Floor PVC

TR

Satine Paslanmaz

Tam Boy

Krom Kaplama

Lazer Kesim

Rosa Beta Granit

ENG

Stainless Steel

FW/FH

Chrome Plating

Laser Cut

Rosa Beta Granite

Tavan



Kaplama



Zemin





ELG-002

Kaplama / Material

Ayna / Mirror

Küpeřteler / Handrails

Tavanlar / Ceilings

Zemin / Floor PVC

TR

Satine Paslanmaz

Tam Boy

Krom Kaplama

Lazer Kesim

Özel Desen PVC

ENG

Stainless Steel

FW/FH

Chrome Plating

Laser Cut

Custom Pattern PVC

Tavan



Kaplama



Zemin





ELG-003

Kaplama / Material

Ayna / Mirror

Küpeřteler / Handrails

Tavanlar / Ceilings

Zemin / Floor PVC

TR

Satine Paslanmaz

Tam Boy

Krom Kaplama

Lazer Kesim

Özel Desen PVC

ENG

Stainless Steel

FW/FH

Chrome Plating

Laser Cut

Custom Pattern PVC

Tavan



Kaplama



Zemin





ELG-004

Kaplama / Material

Ayna / Mirror

Küpeřteler / Handrails

Tavanlar / Ceilings

Zemin / Floor PVC

TR

Decoratif Paslan.

Tam Boy

Krom Kaplama

Lazer Kesim

Özel Desen PVC

ENG

Decorative Stainless

FW/FH

Chrome Plating

Laser Cut

Custom Pattern PVC

Tavan



Kaplama



Zemin

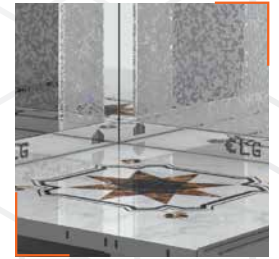

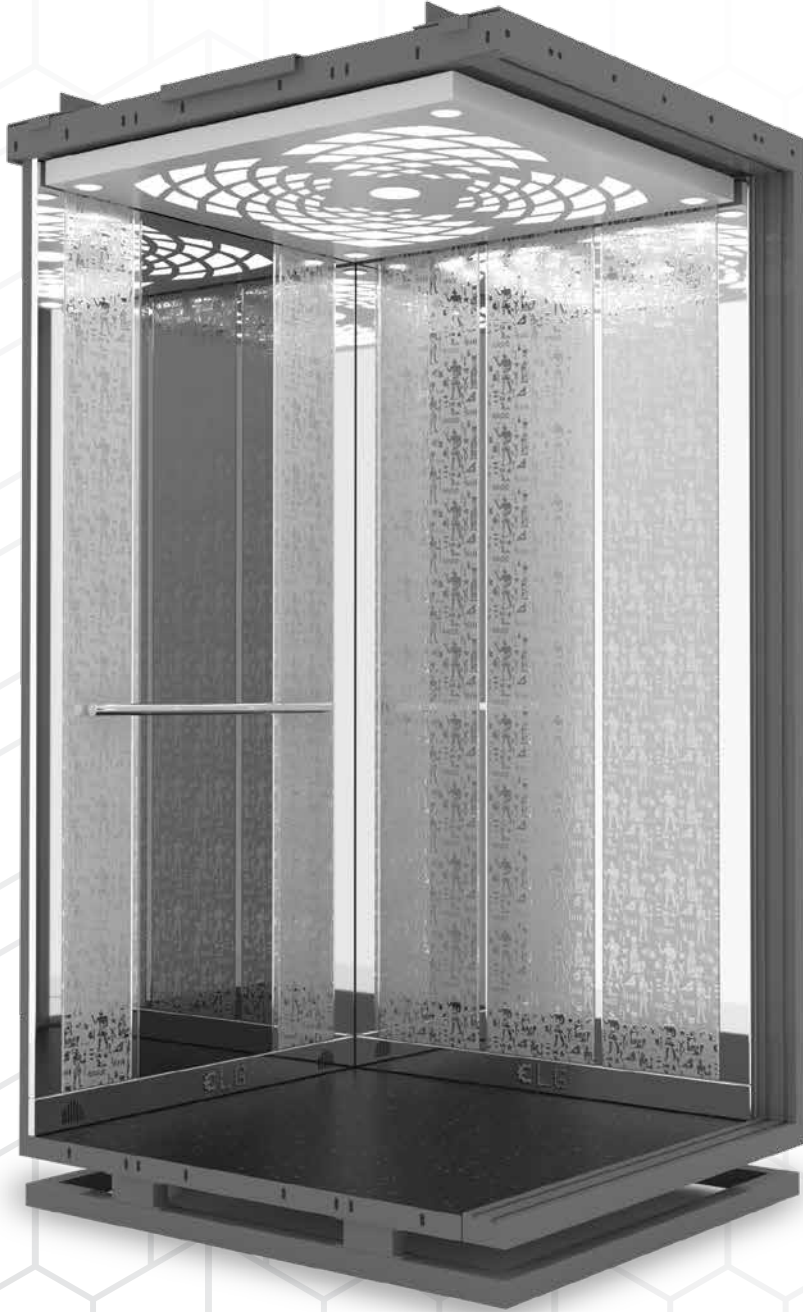

ELG-005

Kaplama / Material

Ayna / Mirror

Küpeřteler / Handrails

Tavanlar / Ceilings

Zemin / Floor PVC

TR

Decoratif Paslan.

Tam Boy

Krom Kaplama

Lazer Kesim

Star Galaxy

ENG

Decorative Stainless

FW/FH

Chrome Plating

Laser Cut

Star Galaxy

Tavan



Kaplama

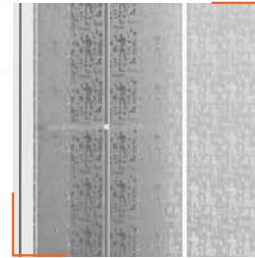

Zemin

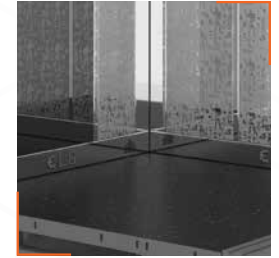



ELG-006

Kaplama / Material

Ayna / Mirror

Küpeřteler / Handrails

Tavanlar / Ceilings

Zemin / Floor PVC

TR

Decoratif Paslan.

Tam Boy

Krom Kaplama

Lazer Kesim

Özel Desen PVC

ENG

Decorative Stainless

FW/FH

Chrome Plating

Laser Cut

Custom Pattern PVC

Tavan



Kaplama

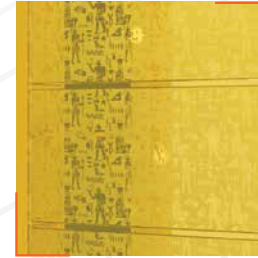

Zemin





ELG-007

Kaplama / Material

Ayna / Mirror

Küpeřteler / Handrails

Tavanlar / Ceilings

Zemin / Floor PVC

TR

Decoratif Paslan.

Tam Boy

Krom Kaplama

Lazer Kesim

Özel Desen PVC

ENG

Decorative Stainless

FW/FH

Chrome Plating

Laser Cut

Custom Pattern PVC

Tavan



Kaplama

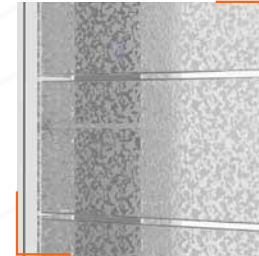

Zemin



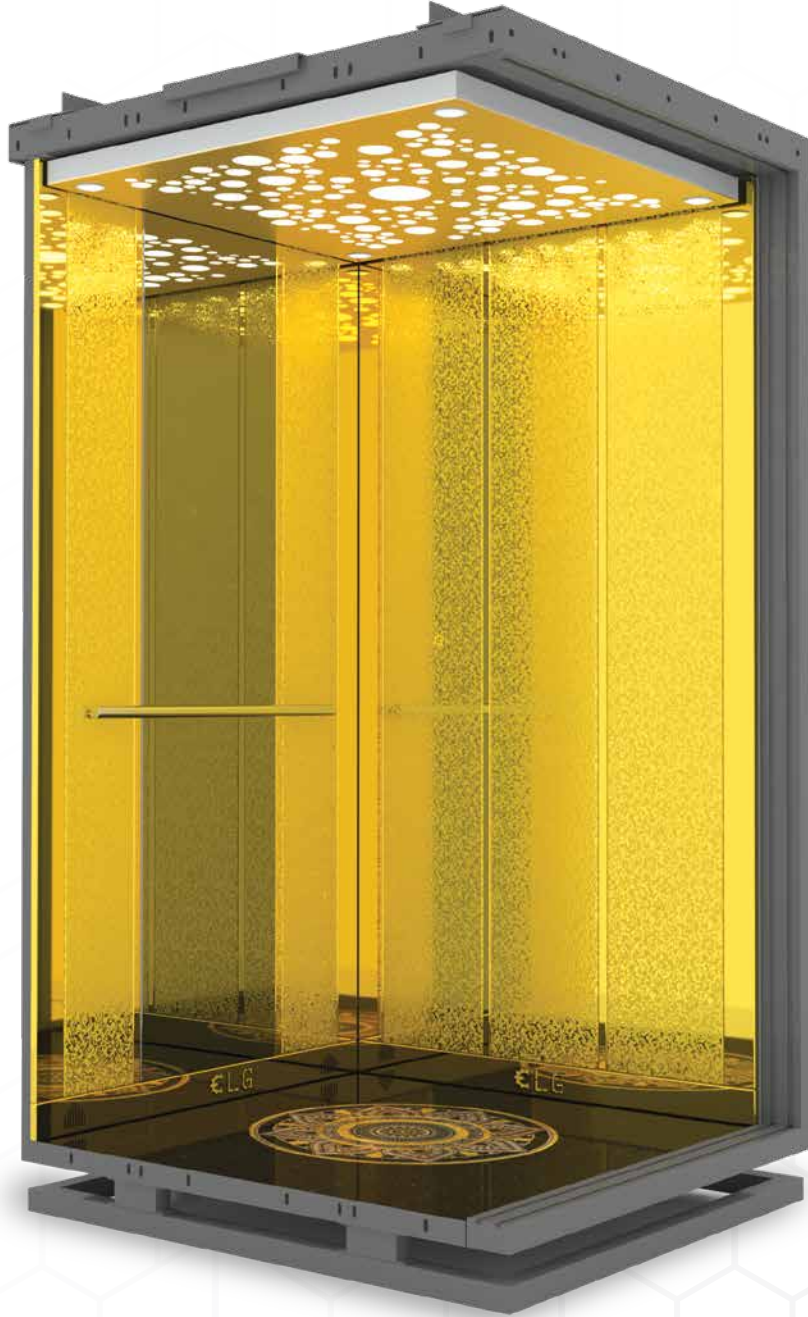

ELG-008

Kaplama / Material

Ayna / Mirror

Küpeřteler / Handrails

Tavanlar / Ceilings

Zemin / Floor PVC

TR

Decoratif Paslan.

Tam Boy

Krom Kaplama

Lazer Kesim

Özel Desen PVC

ENG

Decorative Stainless

FW/FH

Chrome Plating

Laser Cut

Custom Pattern PVC

Tavan



Kaplama

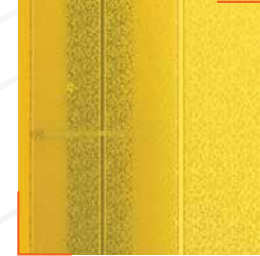

Zemin





ELG-009

Kaplama / Material

Ayna / Mirror

Küpeřteler / Handrails

Tavanlar / Ceilings

Zemin / Floor PVC

TR

Cam / Laminant

Tam Boy

Altın Krom Kaplama

Lazer Kesim

Özel Desen PVC

ENG

Glass / Laminate

FW/FH

Gold Chrome Plating

Laser Cut

Custom Pattern PVC

Tavan



Kaplama



Zemin

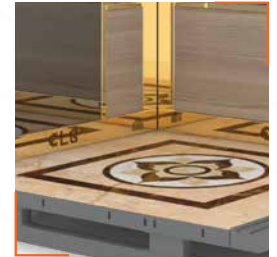



ELG-010

Kaplama / Material

Ayna / Mirror

Küpeřteler / Handrails

Tavanlar / Ceilings

Zemin / Floor PVC

TR

Decoratif Paslan.

Tam Boy

Krom Kaplama

Lazer Kesim

Star Galaxy

ENG

Decorative Stainless

FW/FH

Chrome Plating

Laser Cut

Star Galaxy

Tavan



Kaplama

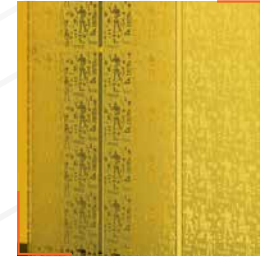

Zemin

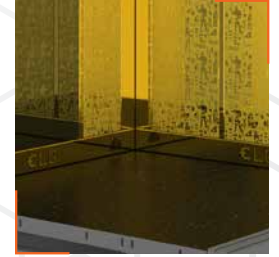



ELG-011

Kaplama / Material

Ayna / Mirror

Küpeřteler / Handrails

Tavanlar / Ceilings

Zemin / Floor PVC

TR

Decoratif Paslan.

Tam Boy

Krom Kaplama

Lazer Kesim

Özel Desen PVC

ENG

Decorative Stainless

FW/FH

Chrome Plating

Laser Cut

Custom Pattern PVC

Tavan



Kaplama



Zemin





ELG-012

Kaplama / Material

Ayna / Mirror

Küpeřteler / Handrails

Tavanlar / Ceilings

Zemin / Floor PVC

TR

Decoratif Paslan.

Tam Boy

Krom Kaplama

Lazer Kesim

Özel Desen PVC

ENG

Decorative Stainless

FW/FH

Chrome Plating

Laser Cut

Custom Pattern PVC

Tavan



Kaplama



Zemin

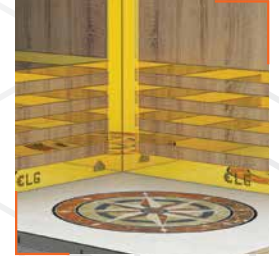



ELG-013

Kaplama / Material

Ayna / Mirror

Küpeřteler / Handrails

Tavanlar / Ceilings

Zemin / Floor PVC

TR

Laminant

Yarım Boy

Krom Kaplama

Lazer Kesim

Özel Desen PVC

ENG

Laminate

FW/PH

Chrome Plating

Laser Cut

Custom Pattern PVC

Tavan



Kaplama



Zemin





ELG-014

Kaplama / Material

Ayna / Mirror

Küpeřteler / Handrails

Tavanlar / Ceilings

Zemin / Floor PVC

TR

Laminant

Yarım Boy

Krom Kaplama

Lazer Kesim

Özel Desen PVC

ENG

Laminate

FW/PH

Chrome Plating

Laser Cut

Custom Pattern PVC

Tavan



Kaplama

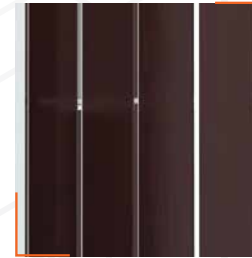

Zemin





ELG-015

Kaplama / Material

Ayna / Mirror

Küpeřteler / Handrails

Tavanlar / Ceilings

Zemin / Floor PVC

TR

Renkli Lamine Cam

Tam Boy

Krom Kaplama

Lazer Kesim

Özel Desen PVC

ENG

Colored Laminated Glass

FW/FH

Chrome Plating

Laser Cut

Custom Pattern PVC

Tavan



Kaplama



Zemin

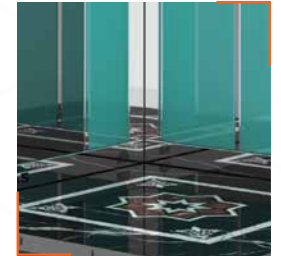



ELG-016

Kaplama / Material

Ayna / Mirror

Küpeřteler / Handrails

Tavanlar / Ceilings

Zemin / Floor PVC

TR

Renkli Lamine Cam

Tam Boy

Krom Kaplama

Lazer Kesim

Star Galaxy

ENG

Colored Laminated Glass

FW/FH

Chrome Plating

Laser Cut

Star Galaxy

Tavan



Kaplama

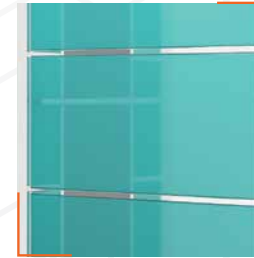

Zemin

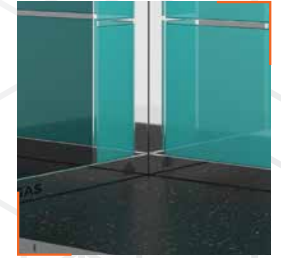



ELG-P01

TR

ENG

Kaplama / Material
Ayna / Mirror
Küpeřteler / Handrails
Tavanlar / Ceilings
Zemin / Floor PVC

Bombeli Cam
-
Krom Kaplama
Lazer Kesim
Star Galaxy

Curved Glass
-
Chrome Plating
Laser Cut
Star Galaxy

ELG-P02

TR

ENG

Kaplama / Material
Ayna / Mirror
Küpeřteler / Handrails
Tavanlar / Ceilings
Zemin / Floor PVC

Düz Lamine Cam
-
Krom Kaplama
Lazer Kesim
Star Galaxy

Flat Laminated Glass
-
Chrome Plating
Laser Cut
Star Galaxy



ELG-S01

TR

Kaplama / Material

Satine
Paslanmaz

Ayna / Mirror

-

Küpeřteler / Handrails

Ek boru

Zemin / Floor PVC

Alüminyum

ENG

Stainless
Steel

-

Single Pipe

Aluminum

ELG-S01

TR

Kaplama / Material

Elektrostatik
boyalı saç tabaka

Ayna / Mirror

-

Küpeřteler / Handrails

-

Zemin / Floor PVC

Alüminyum

ENG

Electrostatic
painted

-

-

Aluminum

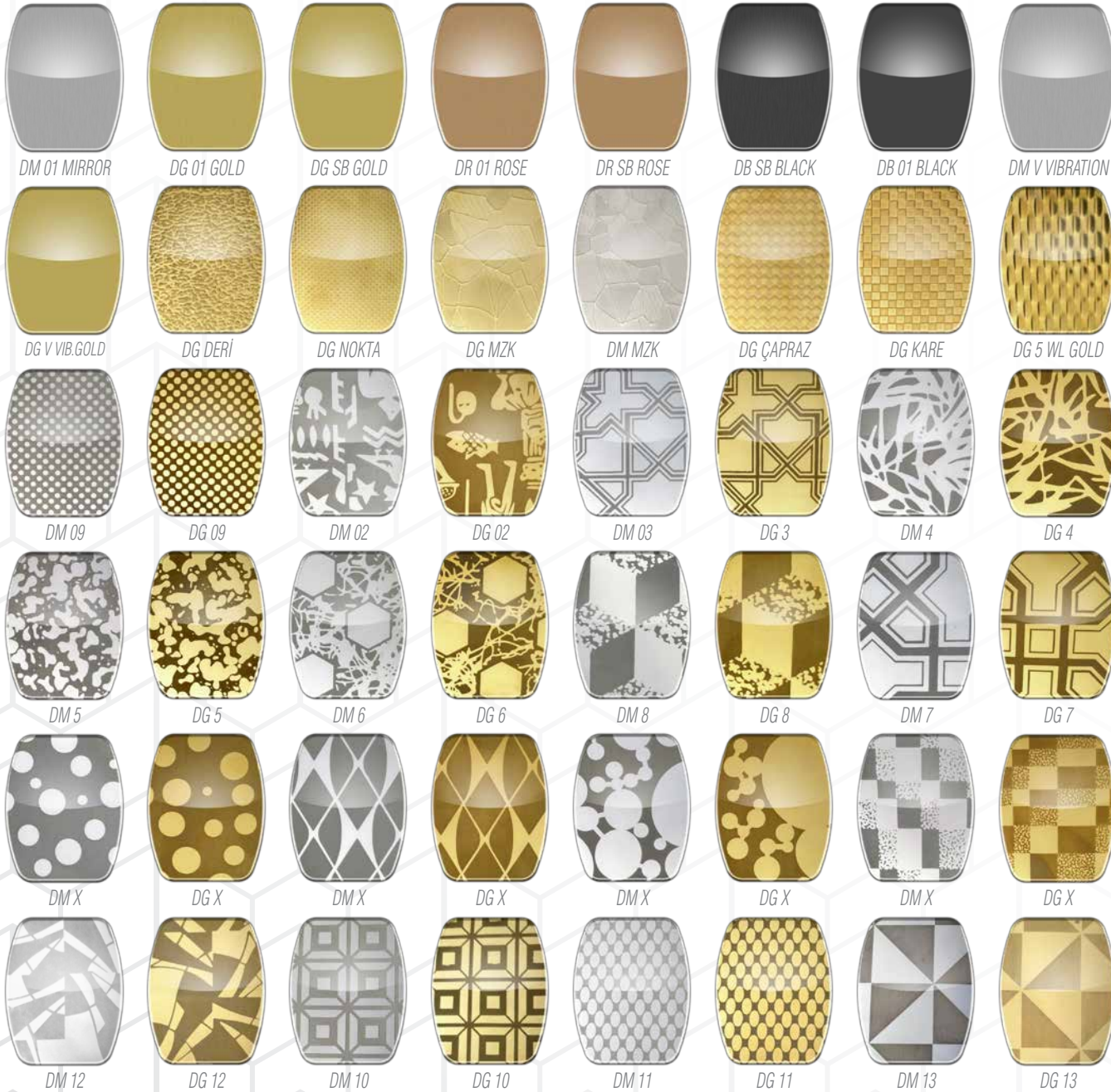



ASD 1039 BUTE	ASD 1039 FLORA	ASD 1044 BUTE	ASD 4019 FLORA	ASD 1050 FLORA	ASD 1053 FLORA	ASD 1066 FLORA
ASD 2003 PARLAK	ASD 2011 PARLAK	ASD 2029 PARLAK	ASD 2030 PARLAK	ASD 2032 PARLAK	ASD 3004 PARLAK	ASD 3023 PARLAK
ASD 3036 BUTE	ASD 3036 PARLAK	ASD 3038 PARLAK	ASD 3040 PARLAK	ASD 3053 PARLAK	ASD 3056A PARLAK	ASD 3056B PARLAK
ASD 3069 BUTE	ASD 3075 PARLAK	ASD 3085 PARLAK	ASD 3088 PARLAK	ASD 3092 PARLAK	ASD 3096 PARLAK	ASD 3099 PARLAK
ASD 3110 PARLAK	ASD 3113 PARLAK	ASD 3120 BUTE	ASD 3124 PARLAK	ASD 3126 BUTE	ASD 3126 PARLAK	ASD 3127 PARLAK



Rosa Beta (Granite)

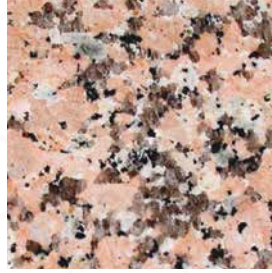

Rosa Porino (Granite)

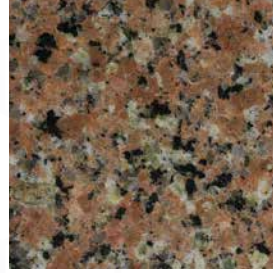

Rosy Pink (Granite)



Star Galaxy (Granite)



Nero Zimbabwe (Granite)



Alexander Black (Marble)



AEZ 3000 (PVC)



AEZ 4100 (PVC)



AEZ 148 (PVC)



AEZ 149 (PVC)



AEZ 150 (PVC)



AEZ 151 (PVC)



AEZ 152 (PVC)



AEZ 153 (PVC)



AEZ 156 (PVC)



AEZ 157 (PVC)



AEZ 158 (PVC)

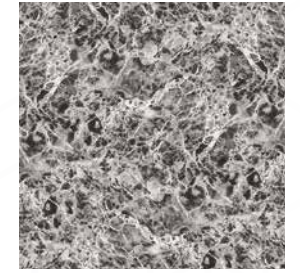

AEZ 209 (PVC)

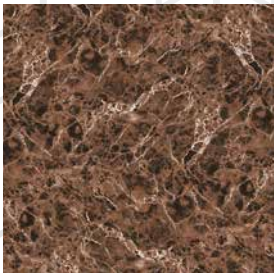

AEZ 210 (PVC)

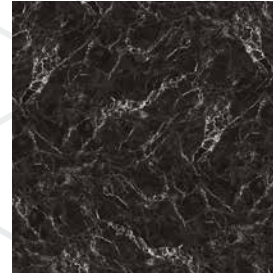

AEZ 211 (PVC)



CKL 01 GREY



CKL 02 BROWN

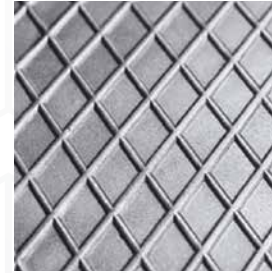

Baklava Sac

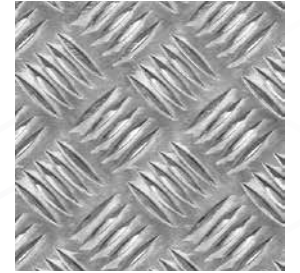

Alüminyum



ELG_T_001



ELG_T_002

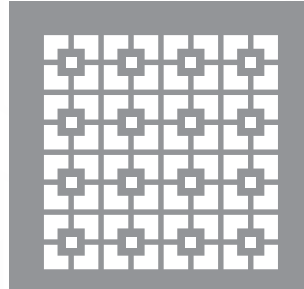

ELG_T_003

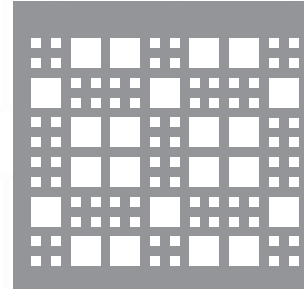

ELG_T_004

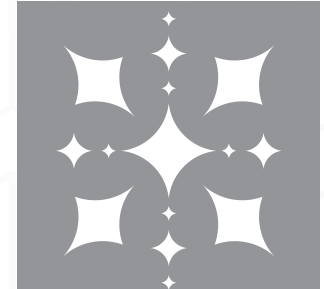

ELG_T_005



ELG_T_006



ELG_T_007



ELG_T_008

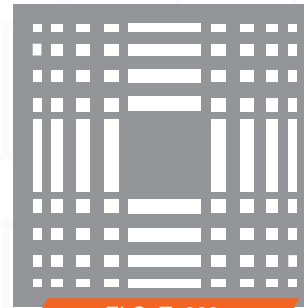

ELG_T_009



ELG_T_010



ELG_T_011

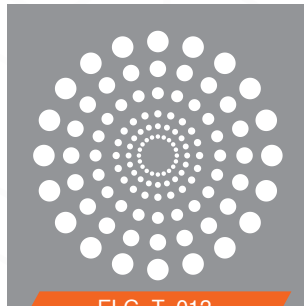

ELG_T_012



ELG_T_013



ELG_T_014



ELG_T_015



ELG_T_016



ELG_T_017

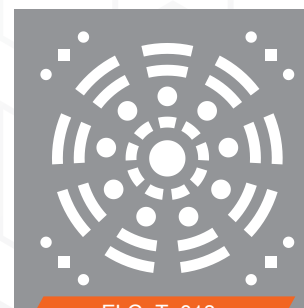

ELG_T_018

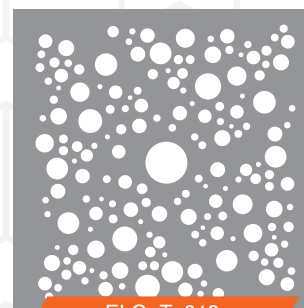

ELG_T_019



ELG_T_020







2 Panel Teleskopik
2 Panels Telescopik



2 Panel Merkezi (Cam)
2 Panels Center (Glass)



2 Panel Merkezi
2 Panels Center



3 Panel Teleskopik
3 Panels Teleskopik



4 Panel Merkezi
4 Panels Center



6 Panel Merkezi
6 Panels Center

MR Asansör Yerleşim Çizimi
MR Elevator Layout Drawing

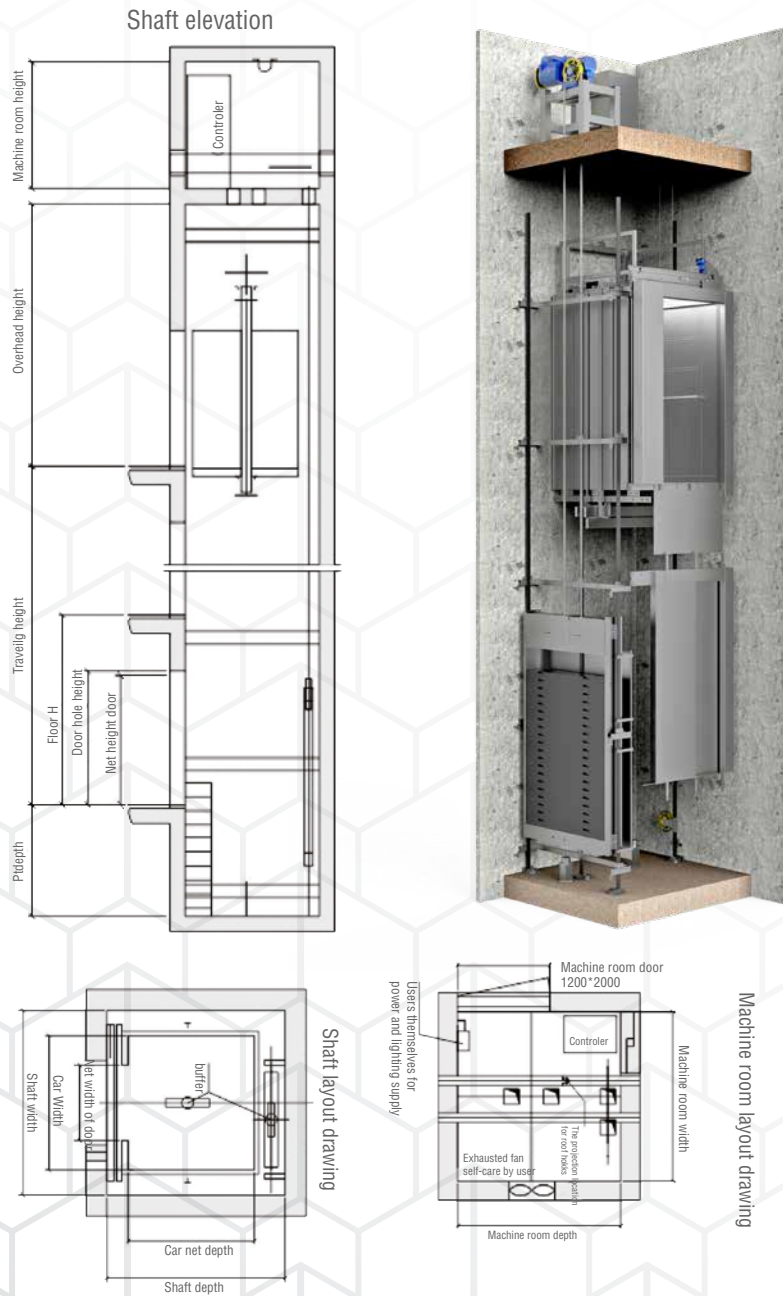

MRL Asansör Yerleşim Çizimi
MRL Elevator Layout Drawing

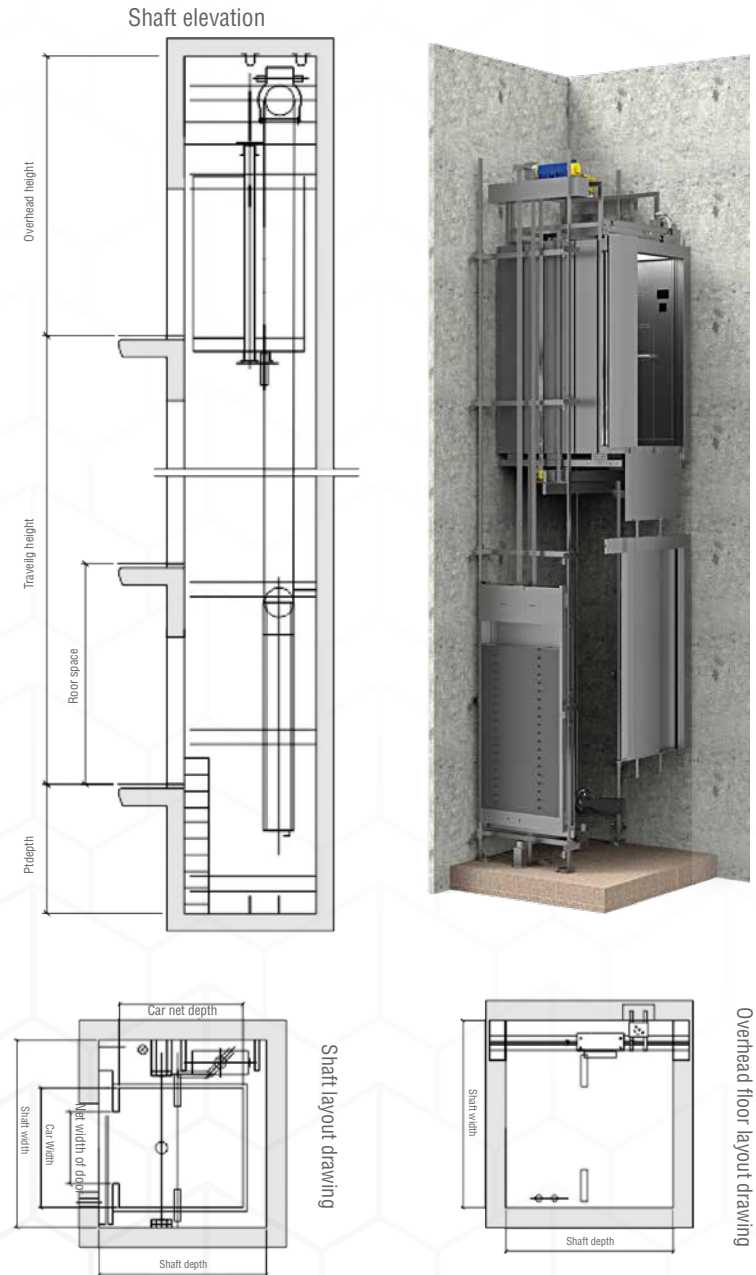

Mrl Motor Şaseleri / Mrl Engine Frames

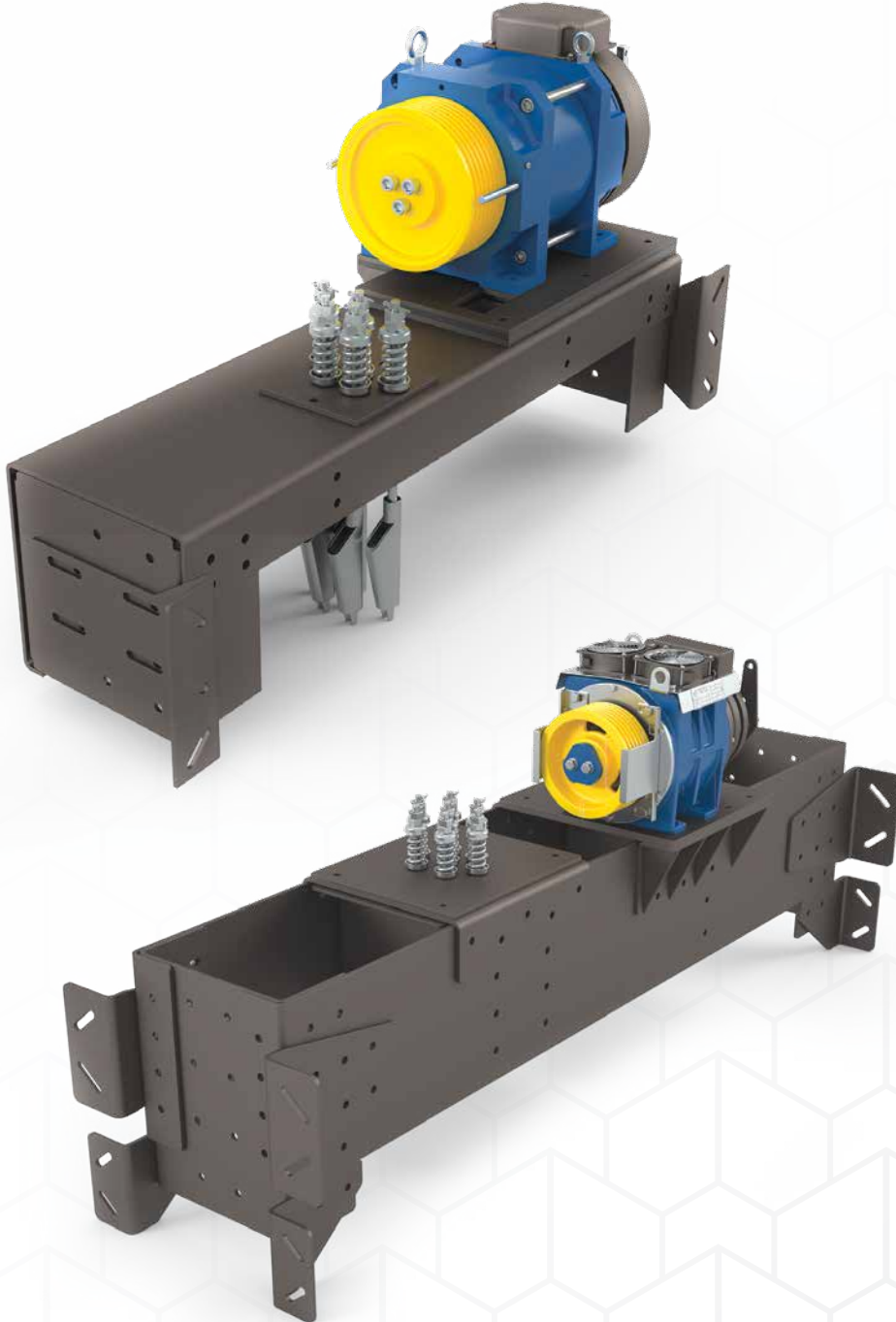

Makine Şaseleri / Machine Frames

Makine Şasesi / Machine Frames



- NPU üretim
- İstenilen kalınlık ve ölçülerde üretim yapılabilir.
- Yüksek mukavemet
- Cıvatalı ayarlanabilir sistem
- Montaj kolaylığı

- NPU production
- Can be produced with demanded thickness and dimensions.
- High durability
- Adjustable bolted system
- Easy installation

Kat ve Kabin Butonyerleri Floor and Cabin Buttons

www.elegas.com.tr



SGST301
94x300 mm



SGTP302
94x300 mm

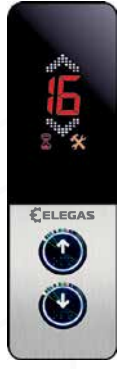

SGT302
94x300 mm

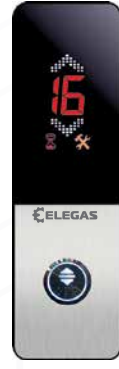

SGT301
94x300 mm



GST301
94x300 mm



PSXT251
85x250 mm



SGTP322
155x300 mm



SGT322 V
155x300 mm



SGT321
155x300 mm



SGN2000
280x2000 mm



SGN2000
280x2000 mm



SGN2000
280x2000 mm



SGN2000 SM
230x2000 mm



SGPN2000 SM
230x2000 mm



SGN2000 SM
230x2000 mm



SGGN1000 SM
230x1000 mm

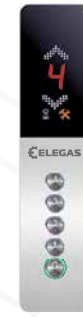

SGN505 SM
120x500 mm

Opsiyonel Gösterge
Optional Display

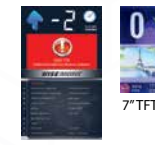

22" TFT



7" TFT



DOTMATRIX



LCD



D60



D64



SWST



WST

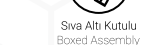

Siva Altı Kutulu
Boxed Assembly



Opsiyonel/Optional
RFID Manyetik Kart Okuyucu
RFID Magnetic Card Reader



Opsiyonel
Optional



Standart Görsel veya
Firma Logonuz
Our Standart Image or
Your Company Logo

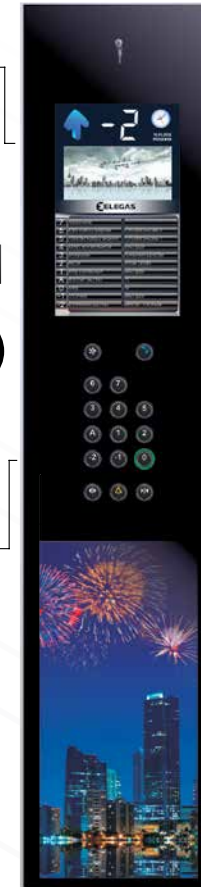

SGN2000
440x2000 mm
Kutu / Box: 405x1965 mm



MT70 DİŞLİSİZ MOTOR
KUMANDA PANOSU
MT70 GEARLESS MOTOR
SPEED CONTROL PANEL

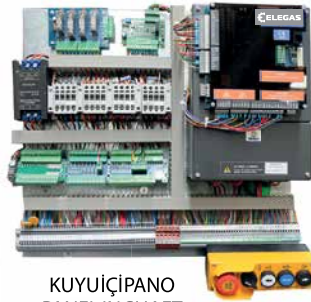

KUYUİÇİPANO
PANEL IN SHAFT

İNCE KAPI KENARI DİŞLİSİZ MOTOR
KUMANDA PANOSU
SLIM DOOR SIDE GEARLESS MOTOR
SPEED CONTROL PANEL



KAPI İÇİ PANO
INDOOR PANEL



MT70 DİŞLİLİ MOTOR KUMANDA PANOSU
MT70 GEARBOX MOTOR SPEED CONTROL PANEL



REVIZYON KUTUSU
MAINTENANCE BOX



REVIZYONKUTUSU
MAINTENANCE BOX



KUYUREVIZYONKUTUSU
SHAFTMAINTENANCE BOX



Dişlisiz Makineler / Gearless Traction Machines

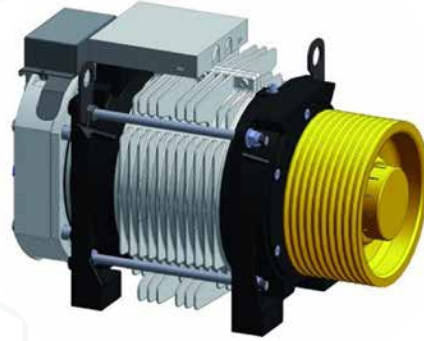

Dişli Makineler / Geared Traction Machines





www.elegas.com.tr
info@elegas.com.tr



SUDAN - NIGERIA - ETHIOPIA - UGANDA - ALGERIA - TUNISIA - RUSSIA - CAMEROON - SAUDI ARABIA - TANZANIA

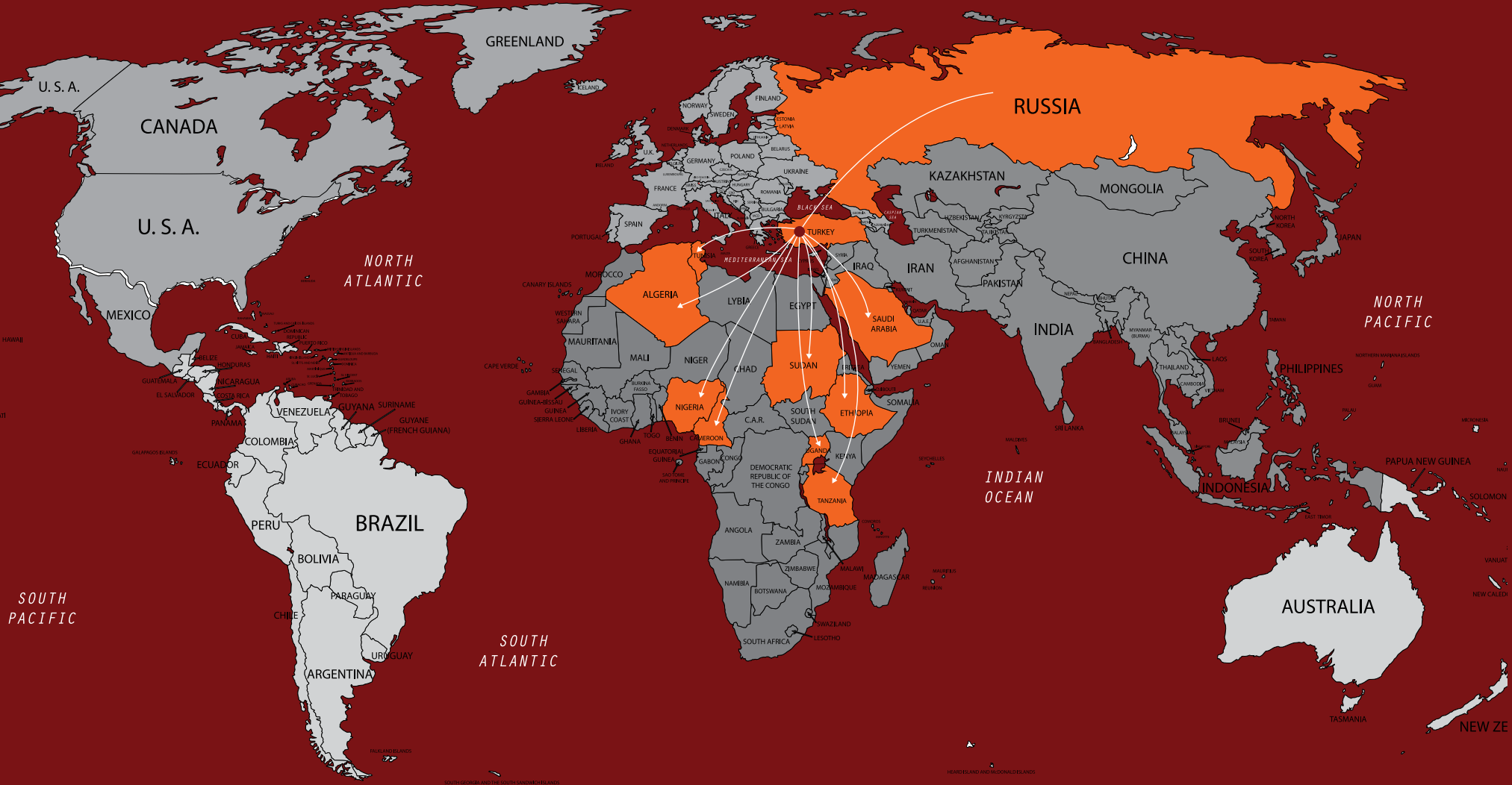

www.elegas.com.tr
info@elegas.com.tr



MERKEZ / HEADQUARTERS

Yakuplu Mh. 144. Sk. No.48/A D:15 Beylikdüzü

İstanbul / **TURKEY**

Tel / Phone: +90 212 485 65 20